

For reference only. See data sheet for the detailed specifications.

Technical Specification

EIA WR	WR90
Frequency Range(GHz)	8.2 - 12.4
Attenuation(dB/m)	0.45 Max.
VSWR	1.15:1 Max.
Average Power(KW)	0.96
Inner Size(mm)	22.86 x 10.16
Max. Twist(deg/m)	308
Min. E-Bend Radius(mm)	66
Min. H-Bend Radius(mm)	132
Flange	FBP100(UBR100)
Jacket	Silicone Rubber
Operating Temp.(°C)	-55 ~ +85
Material	Cu
Length(mm)	450
Net Weight(Kg)	0.29 Around



Outline Drawing (Size: mm)

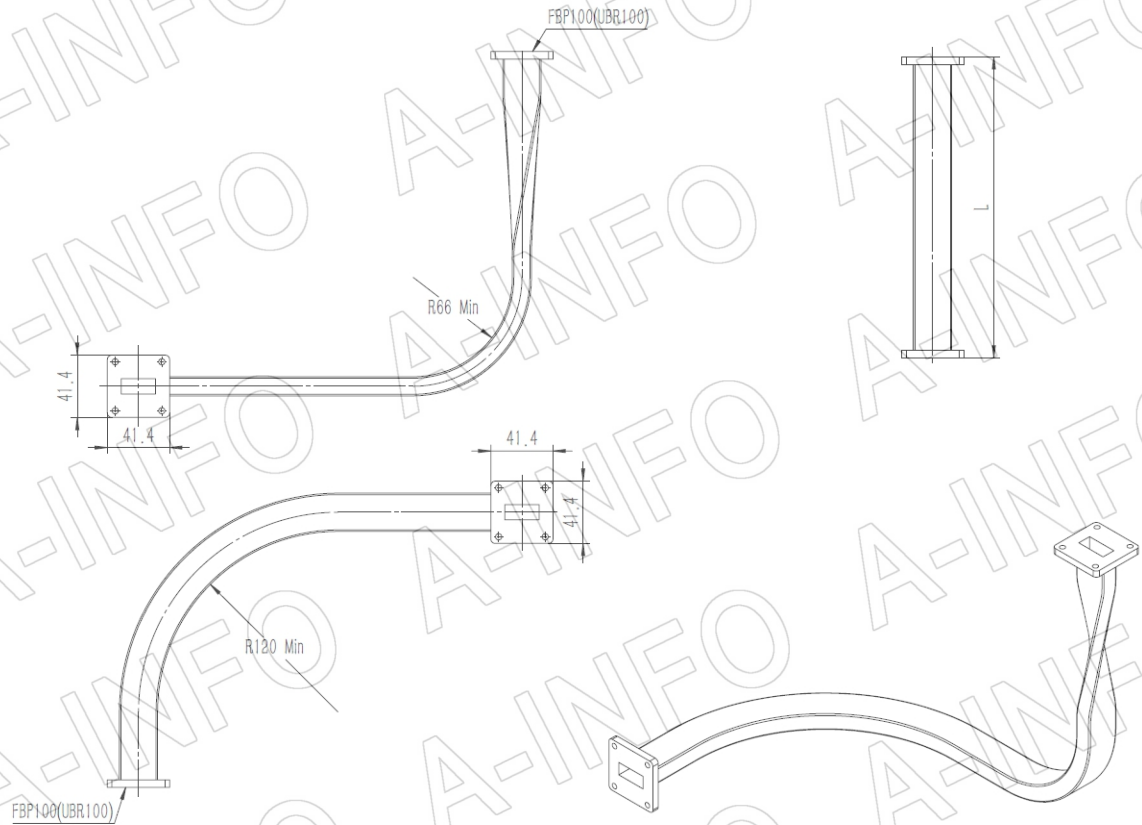

Flange Drawing (Size: mm)

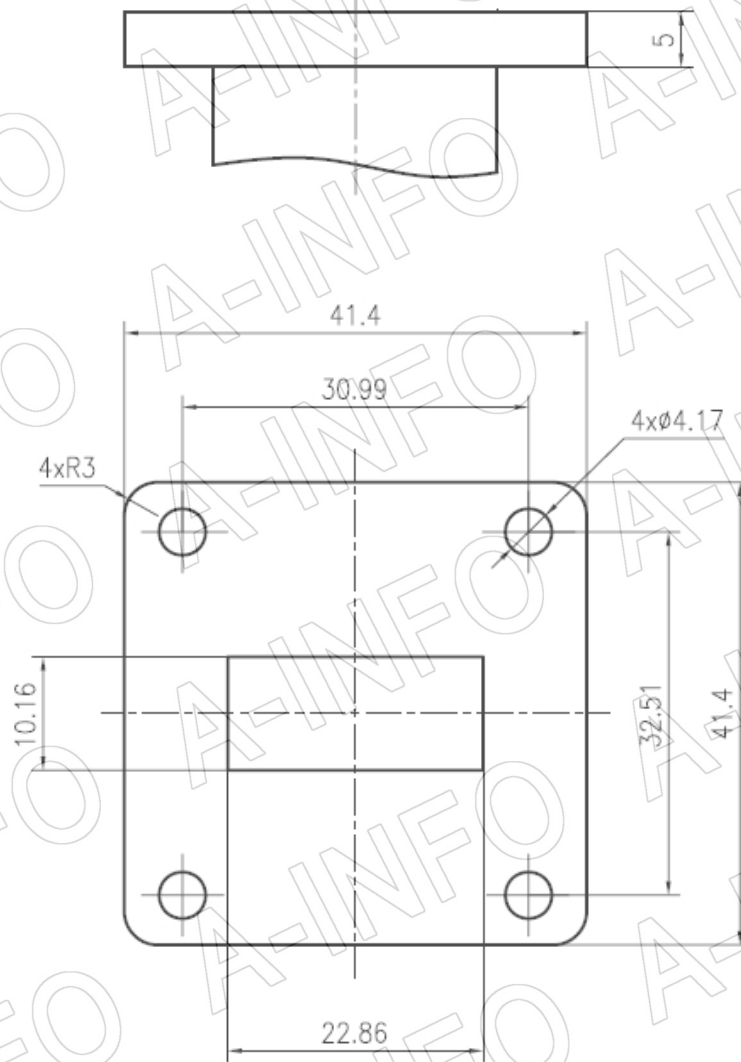

FBP100

Test Results

Attenuation (I.L.: 0.4156dB/m Max.)

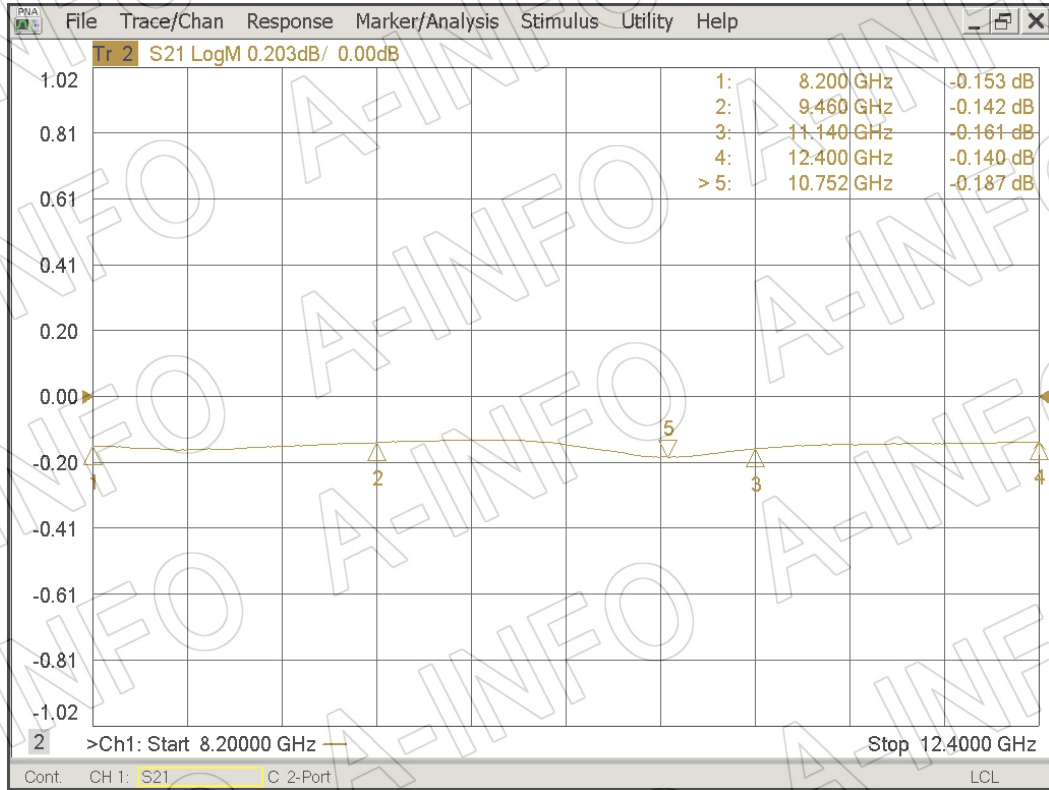

VSWR

